

6.1.-

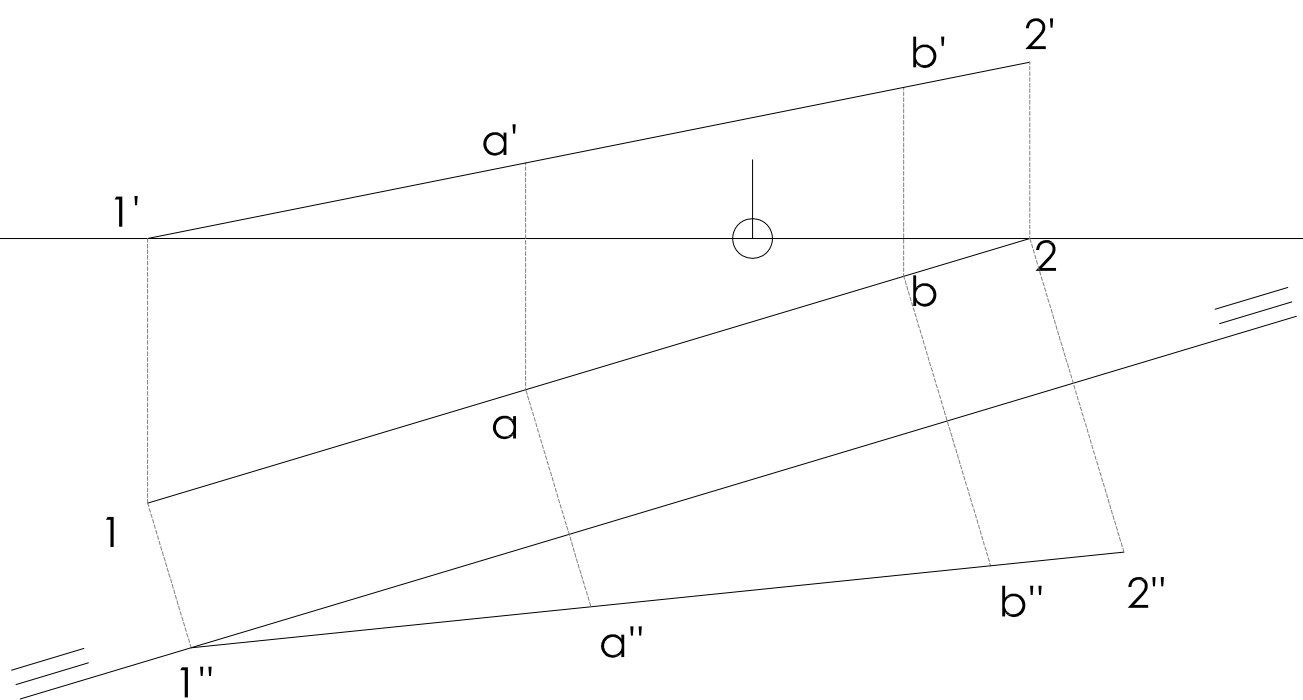

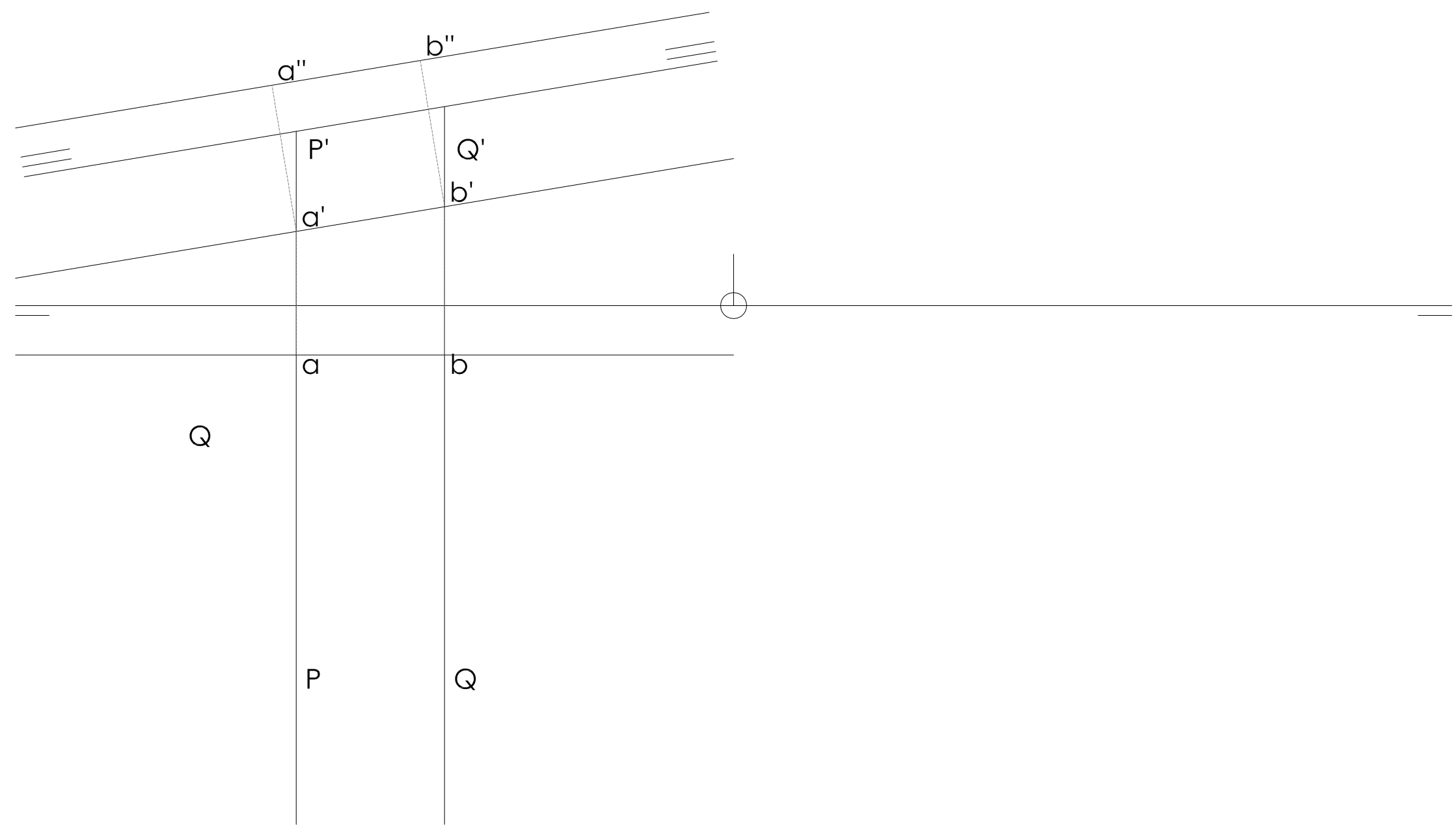

6.3.-



6.4.-

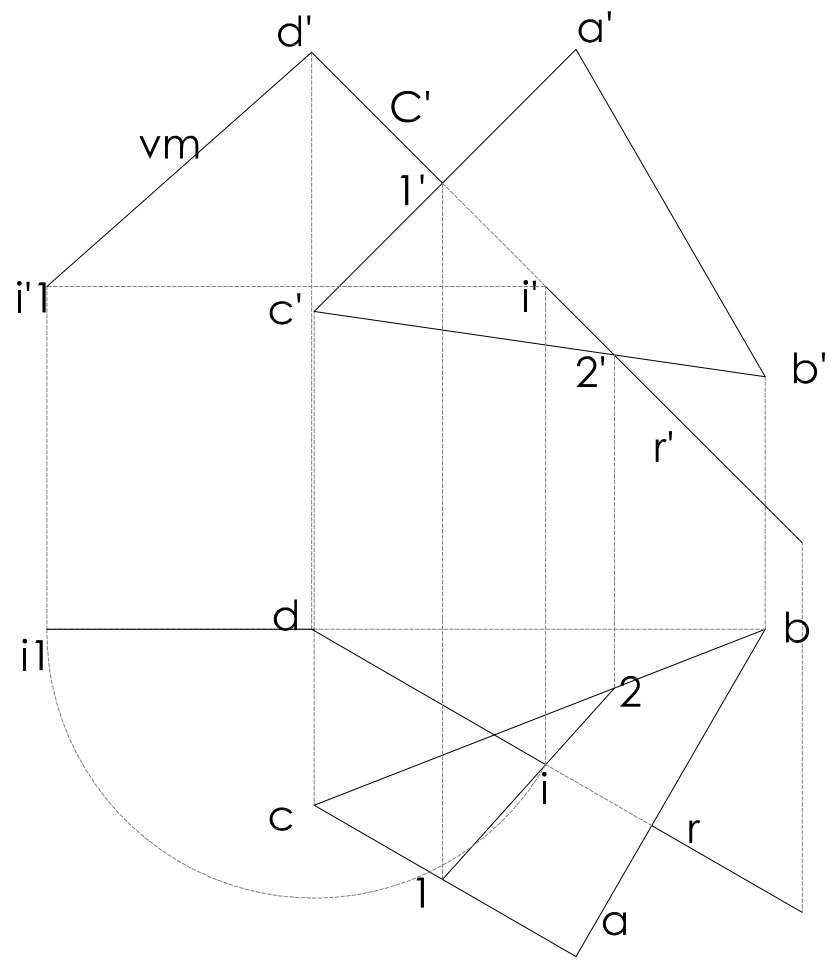

6.5.-

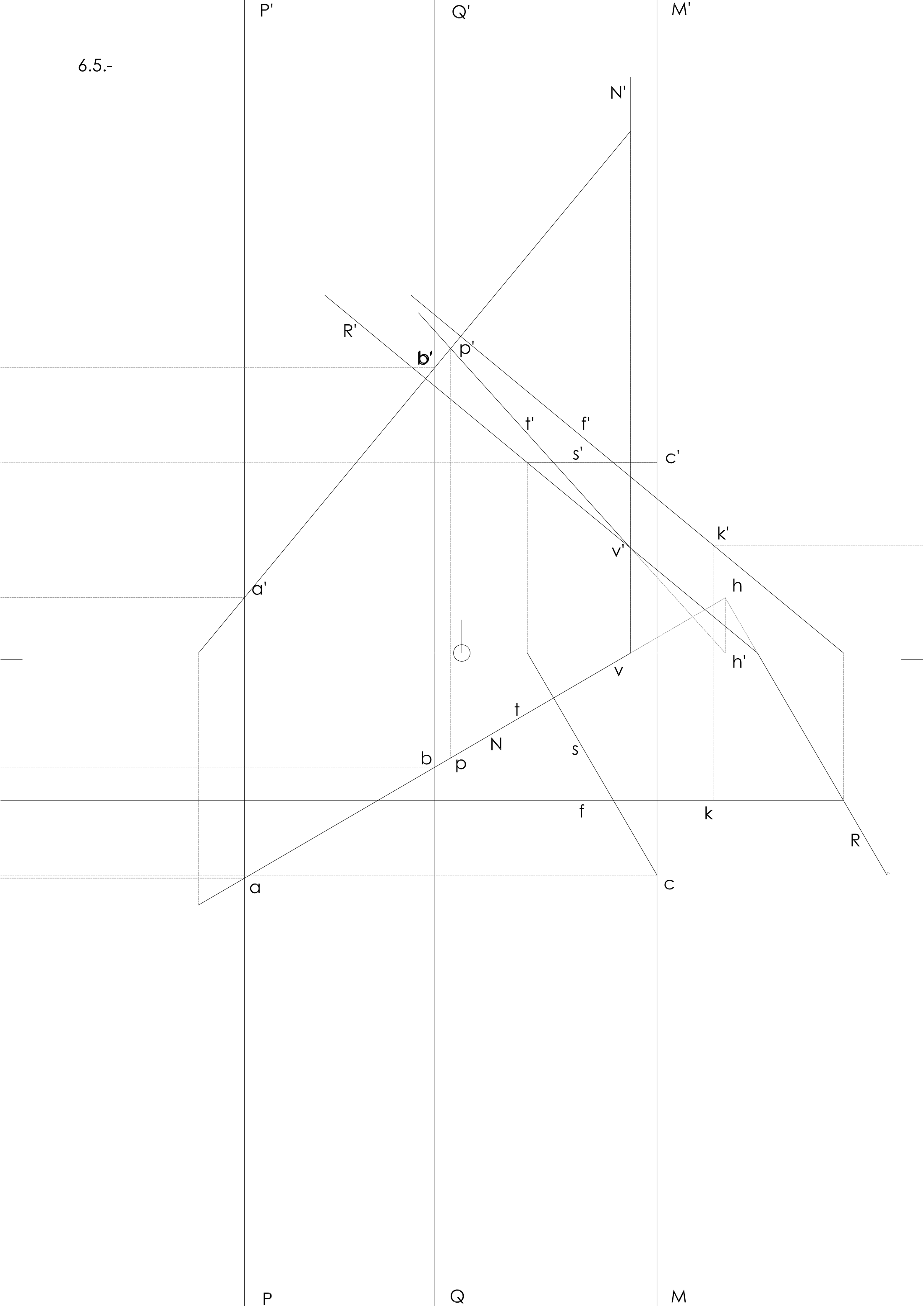

6.5.-

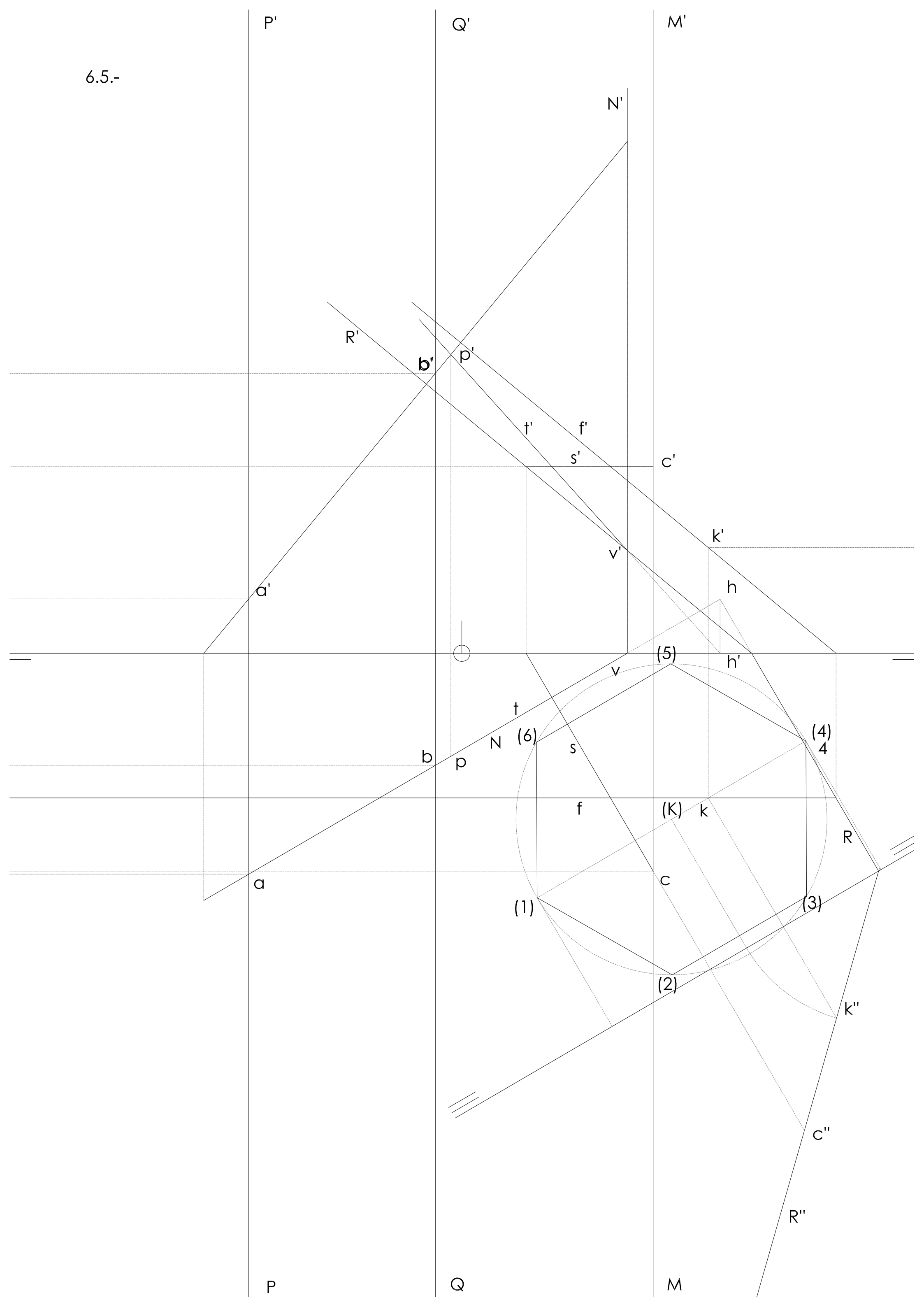

6.5.-

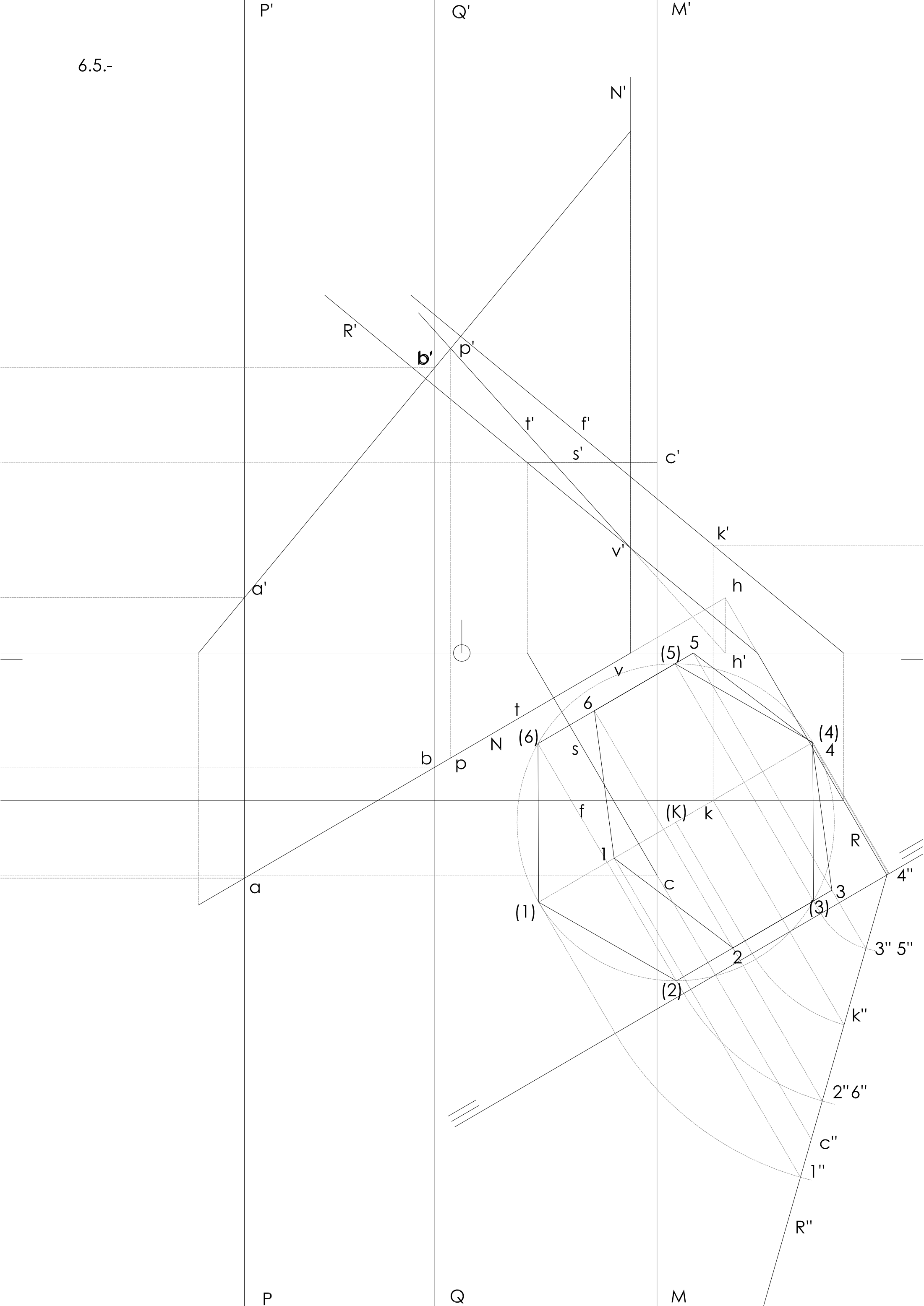

6.5.-

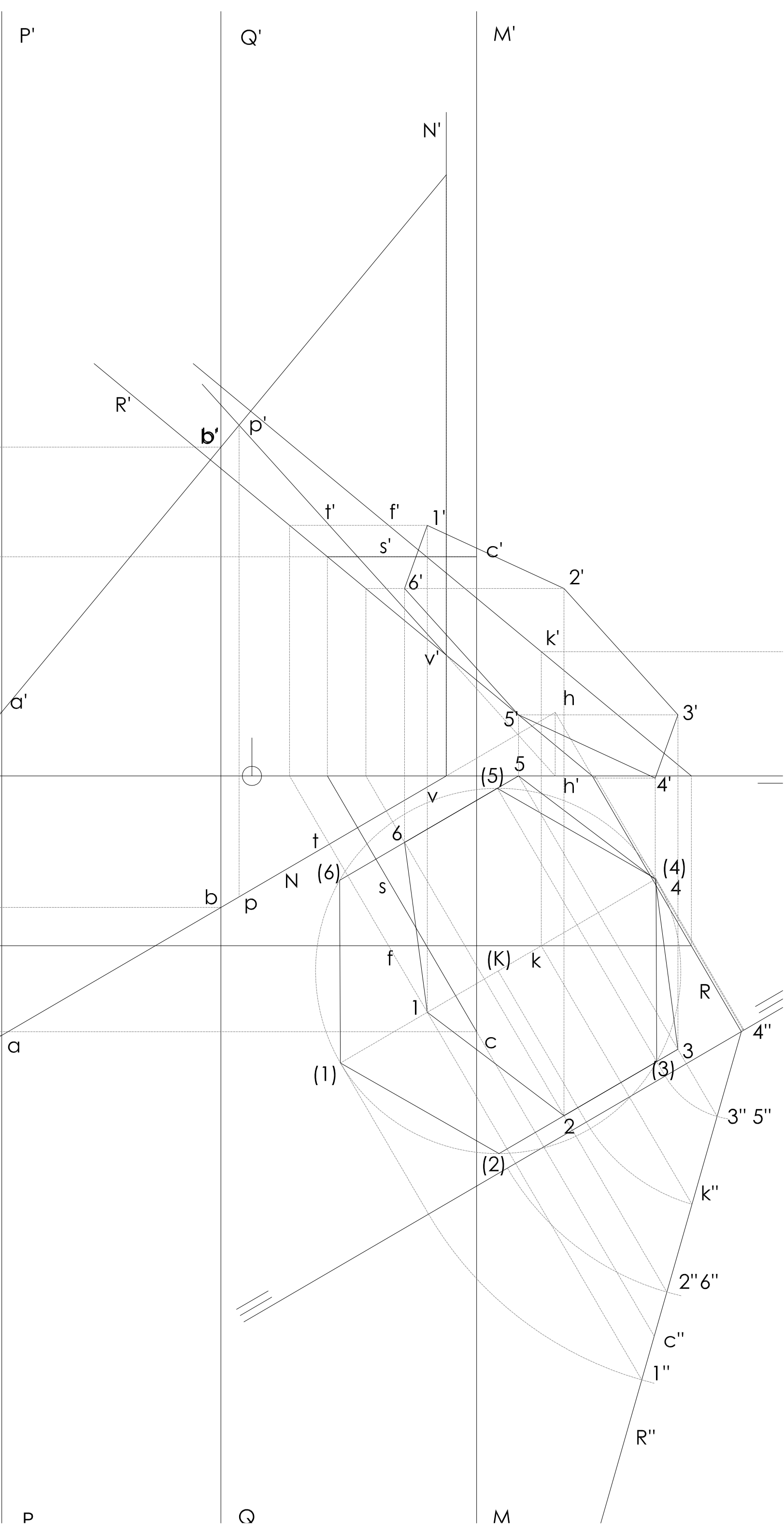



6.5.-

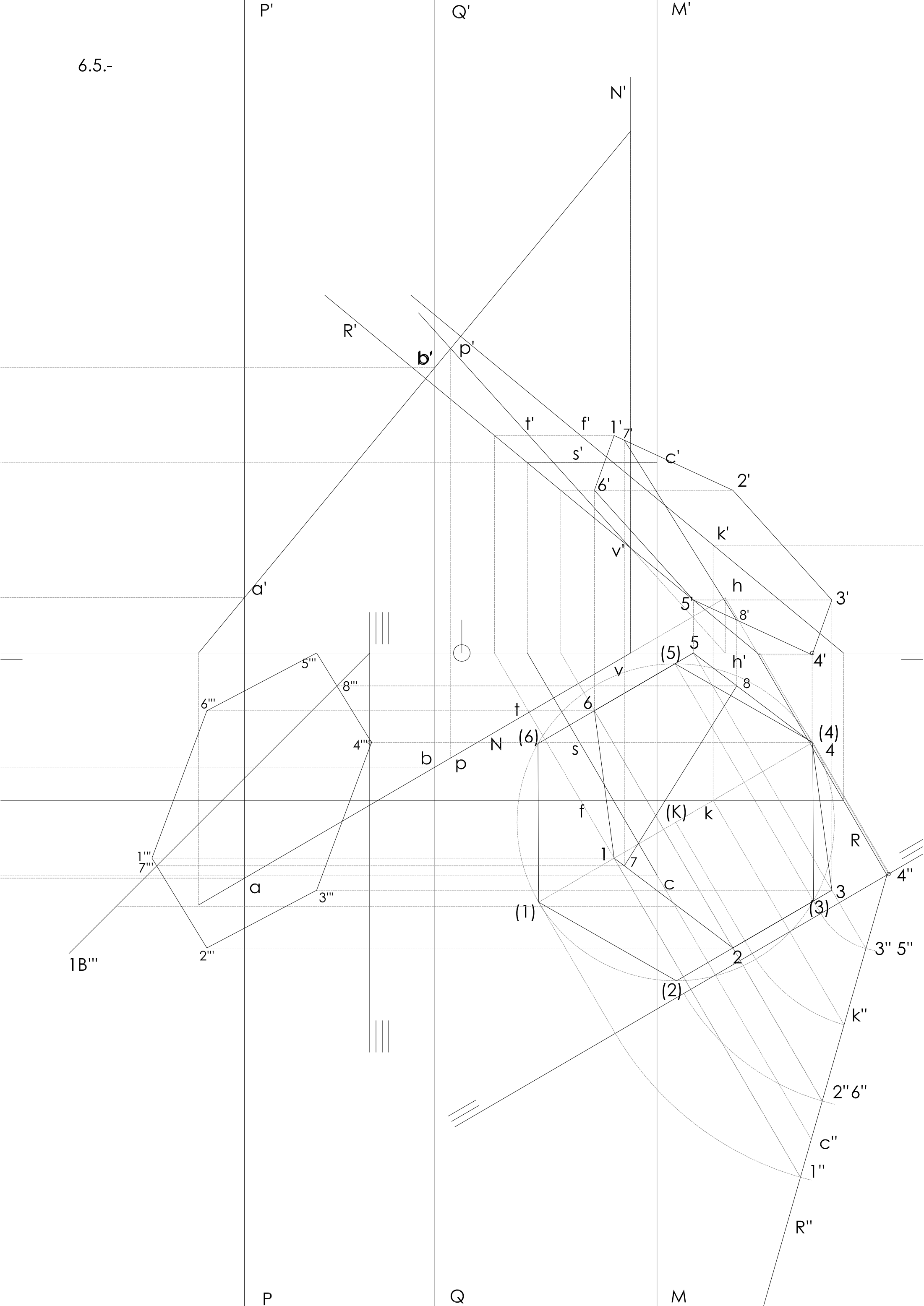

P'

Q'

M'

R'

b'

p'

N'

t'

f'

l'7'

s'

c'

2'

6'

k'

a'

h

8'

3'

5'

5

h'

4'

v

(5)

8

6'''

5'''

8'''

4'''

t

6

(6)

s

b

p

N

(K)

k

f

l

7

R

4''

1'''

7'''

a

3'''

(1)

(3)

3

3

1B'''

2'''

2

(2)

3'' 5''

k''

2'' 6''

c''

1''

R''

P

Q

M



6.5.-

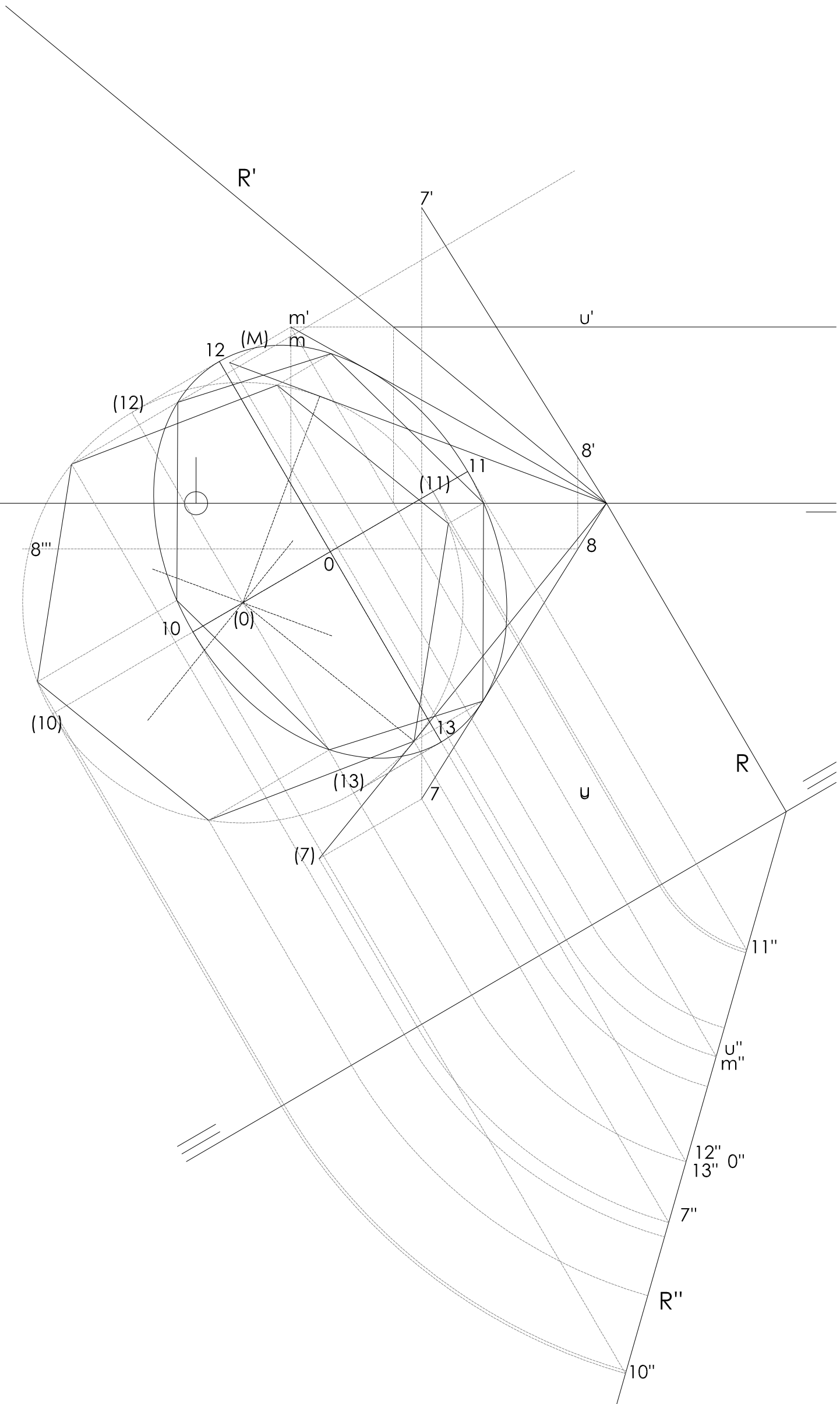

6.6.-

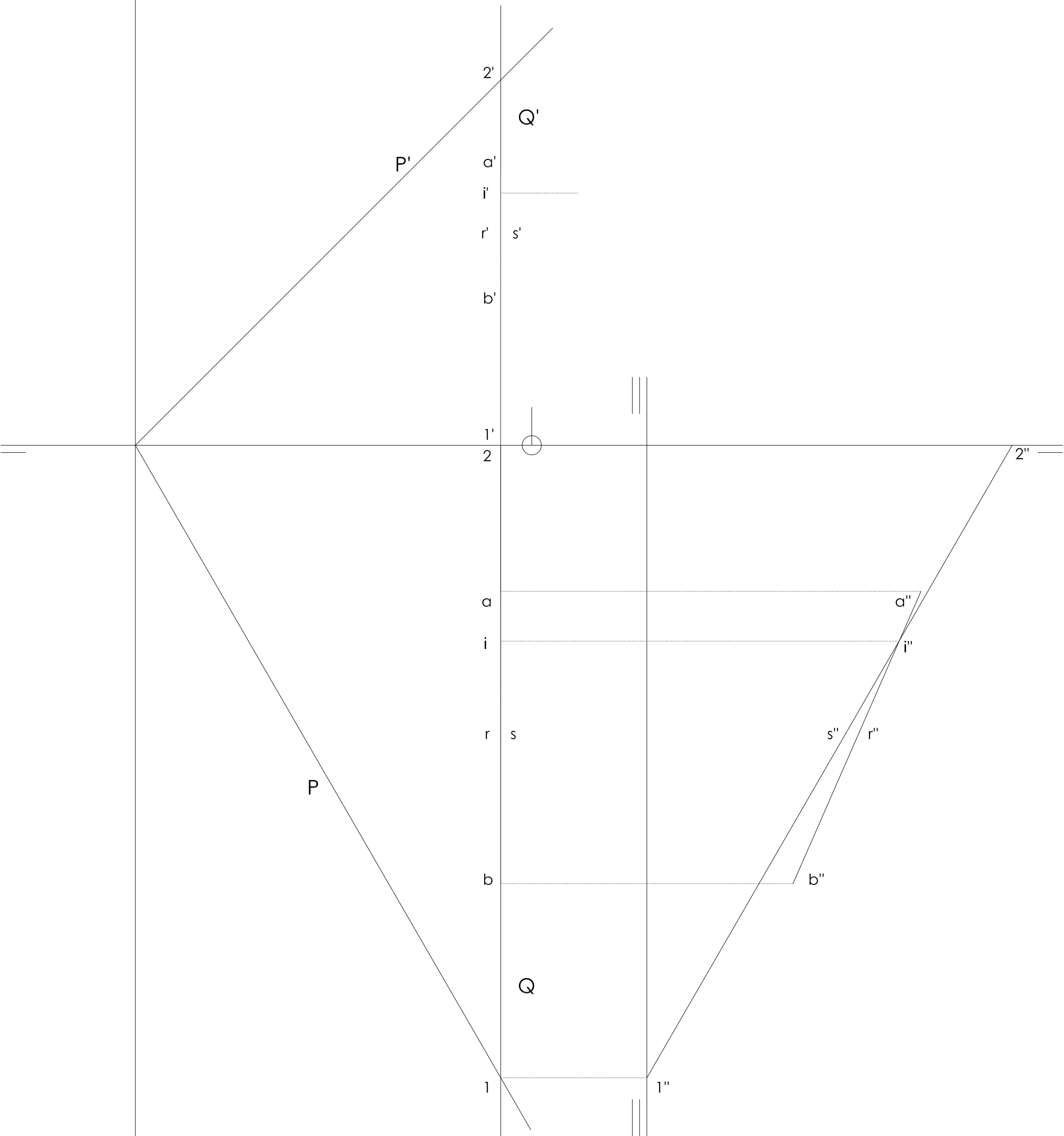

6.6.-

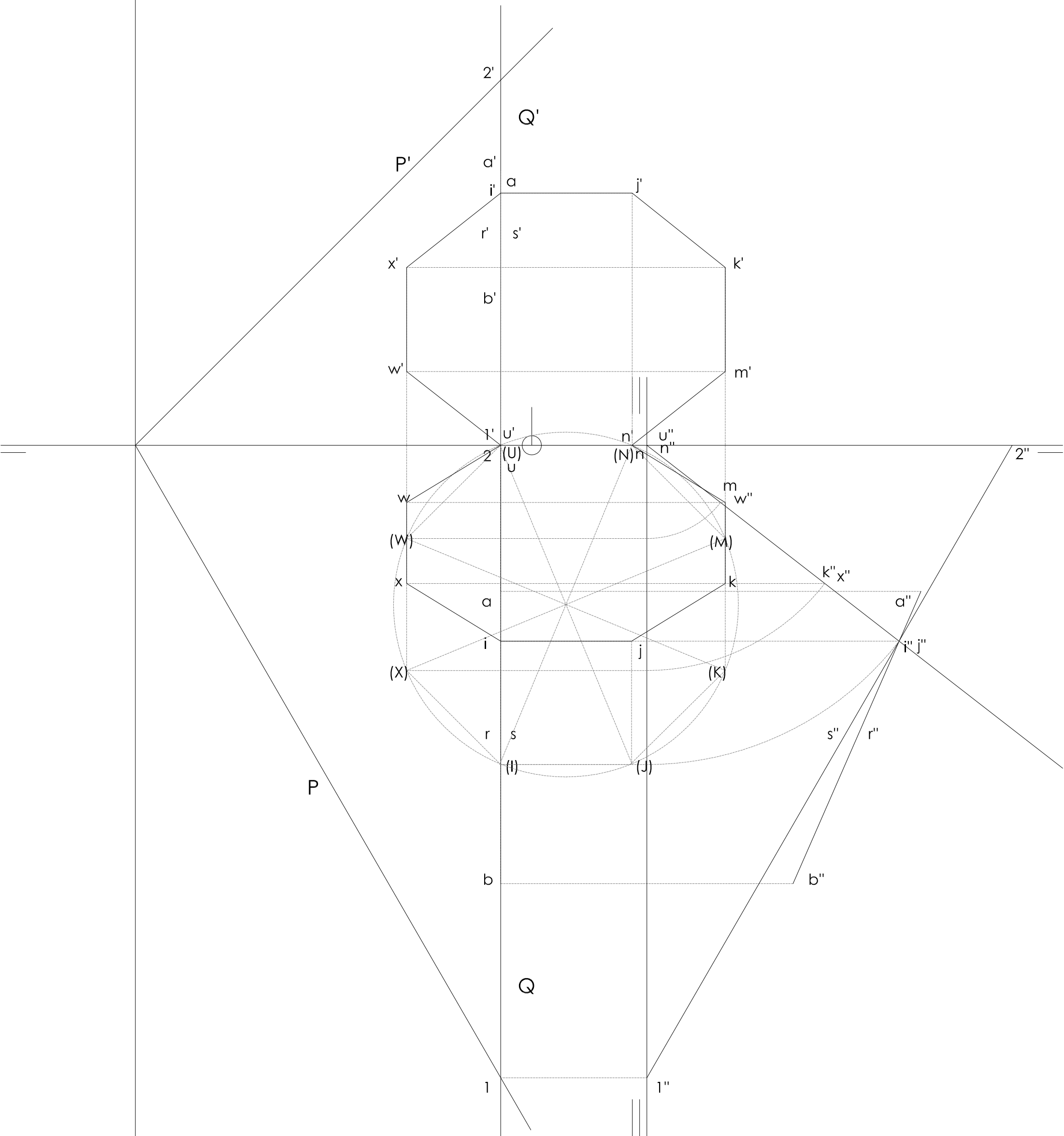
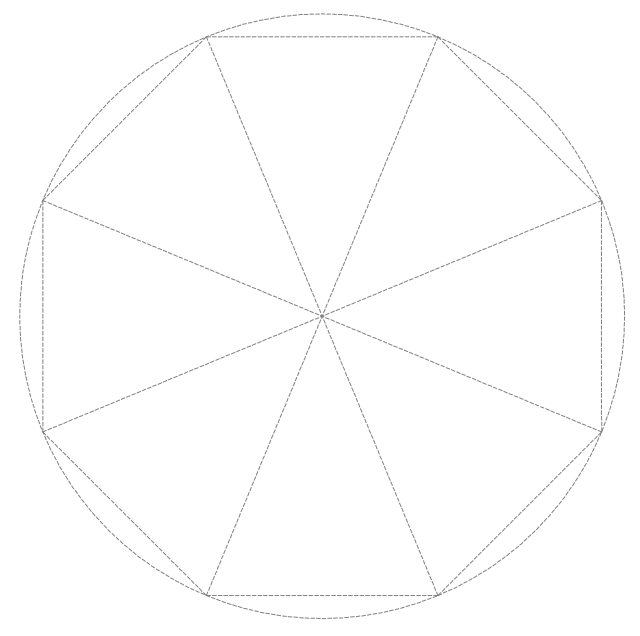
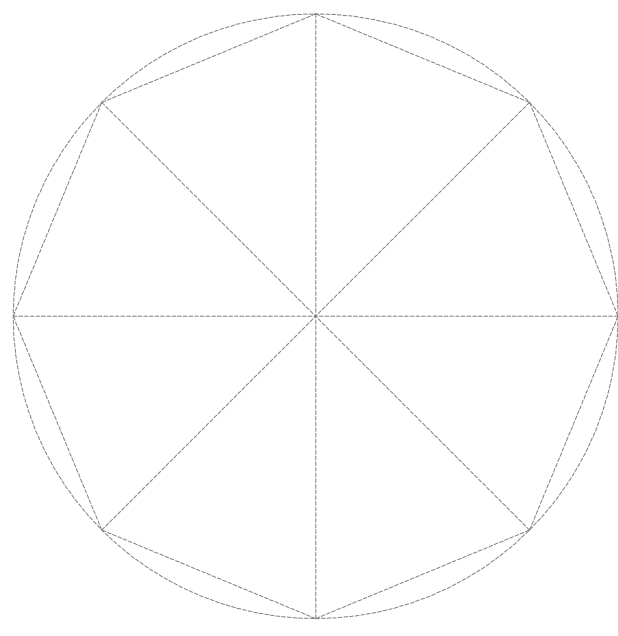

6.7.-

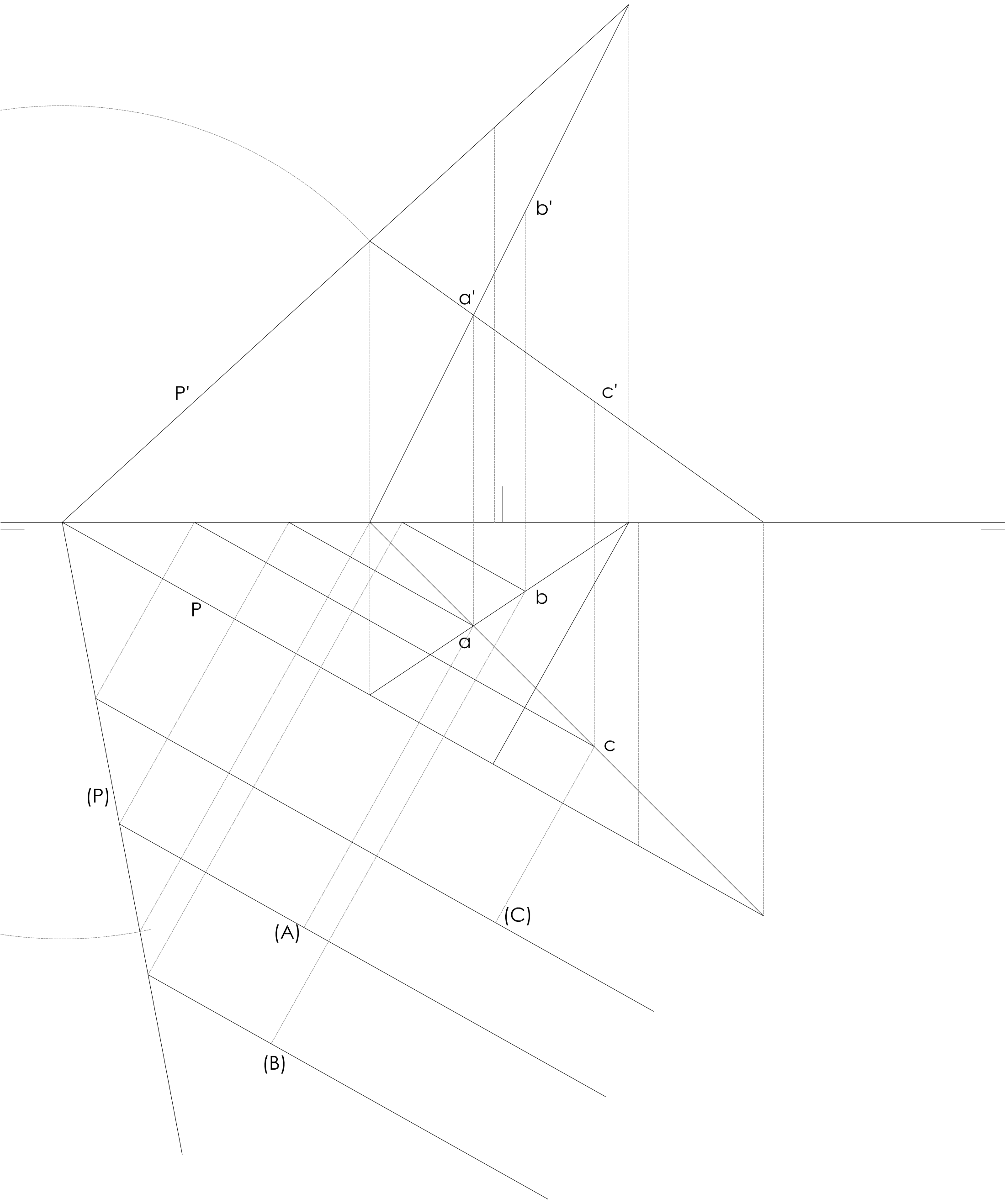

6.7.-

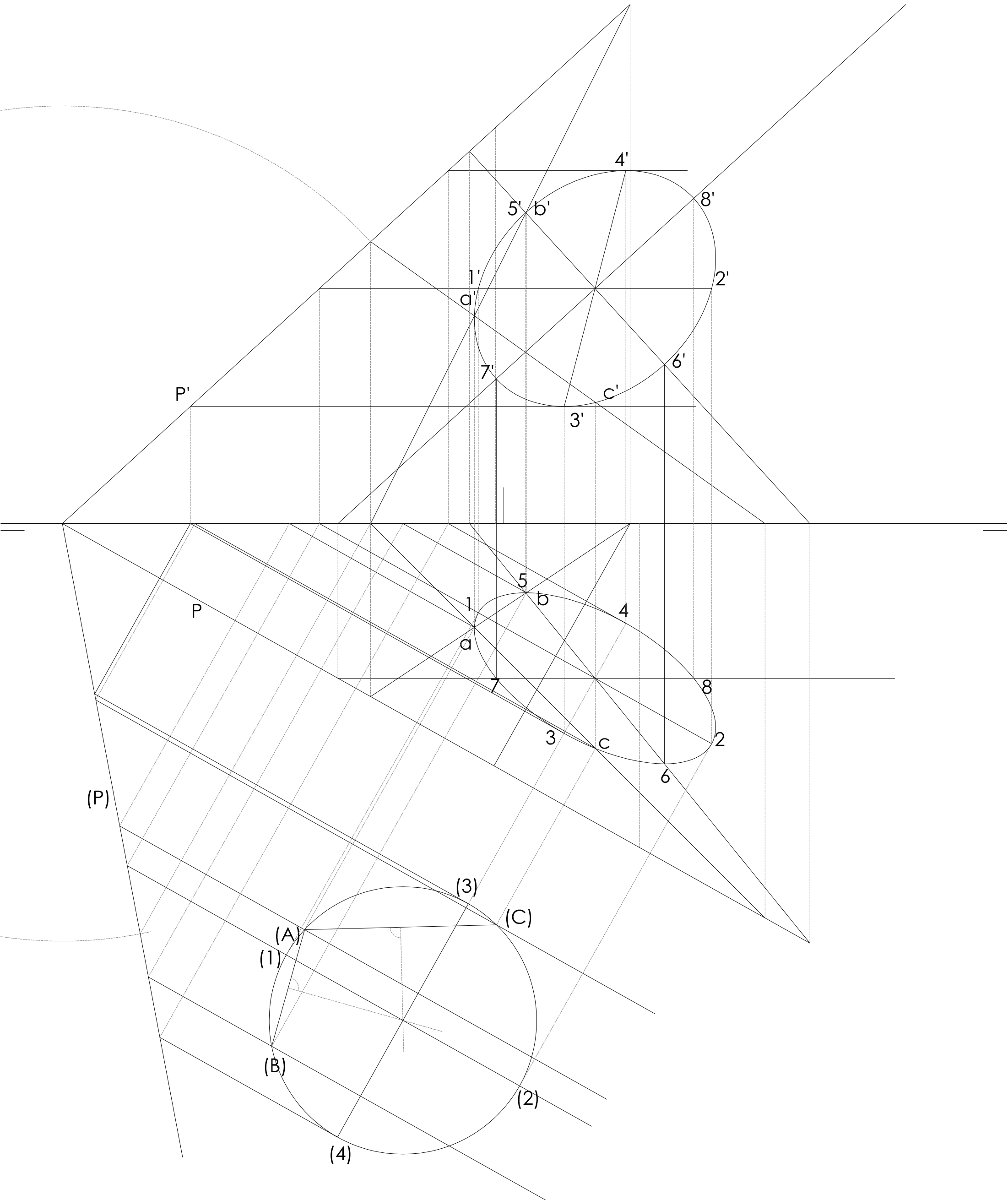

6.8.-

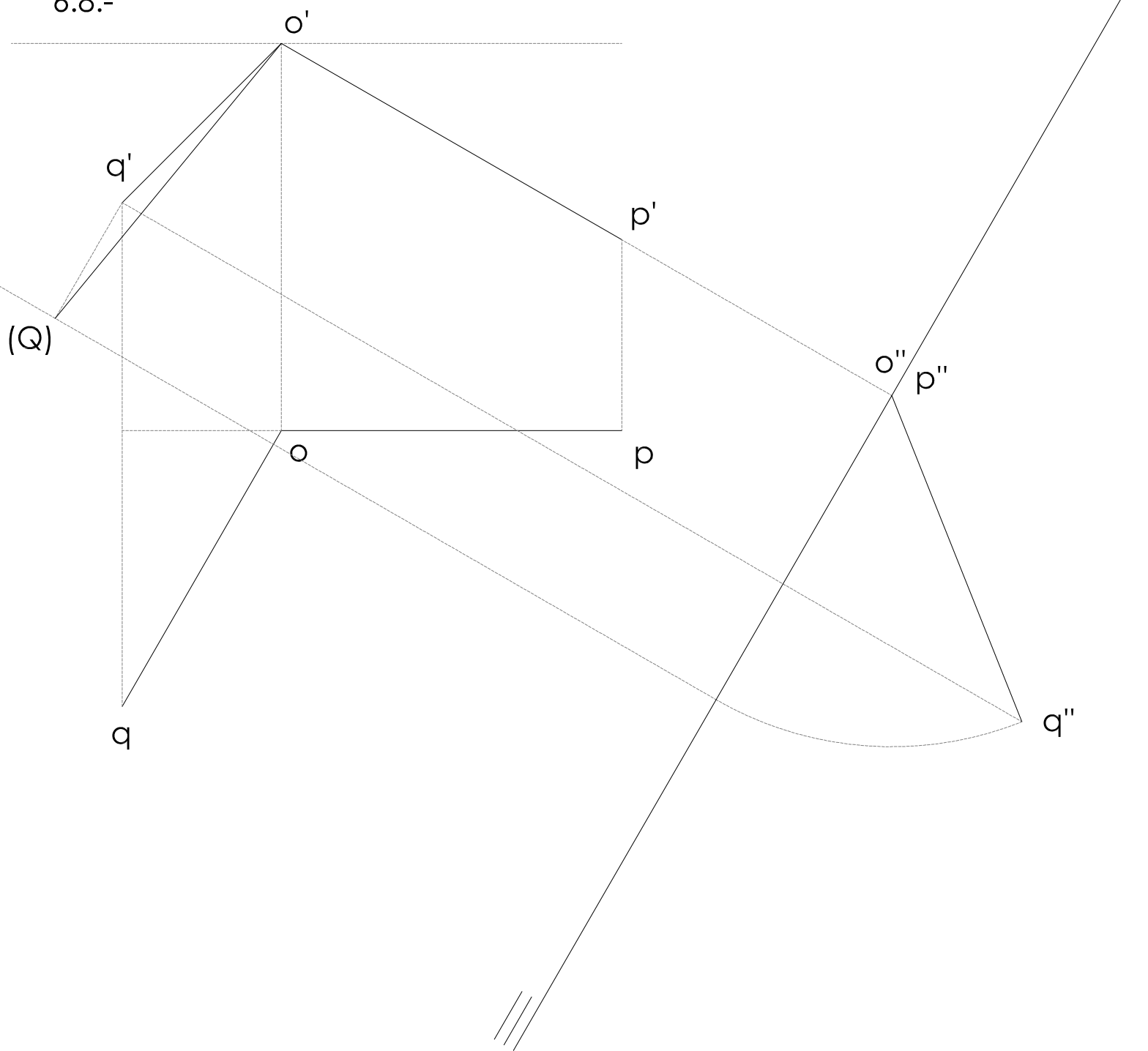



6.8.-

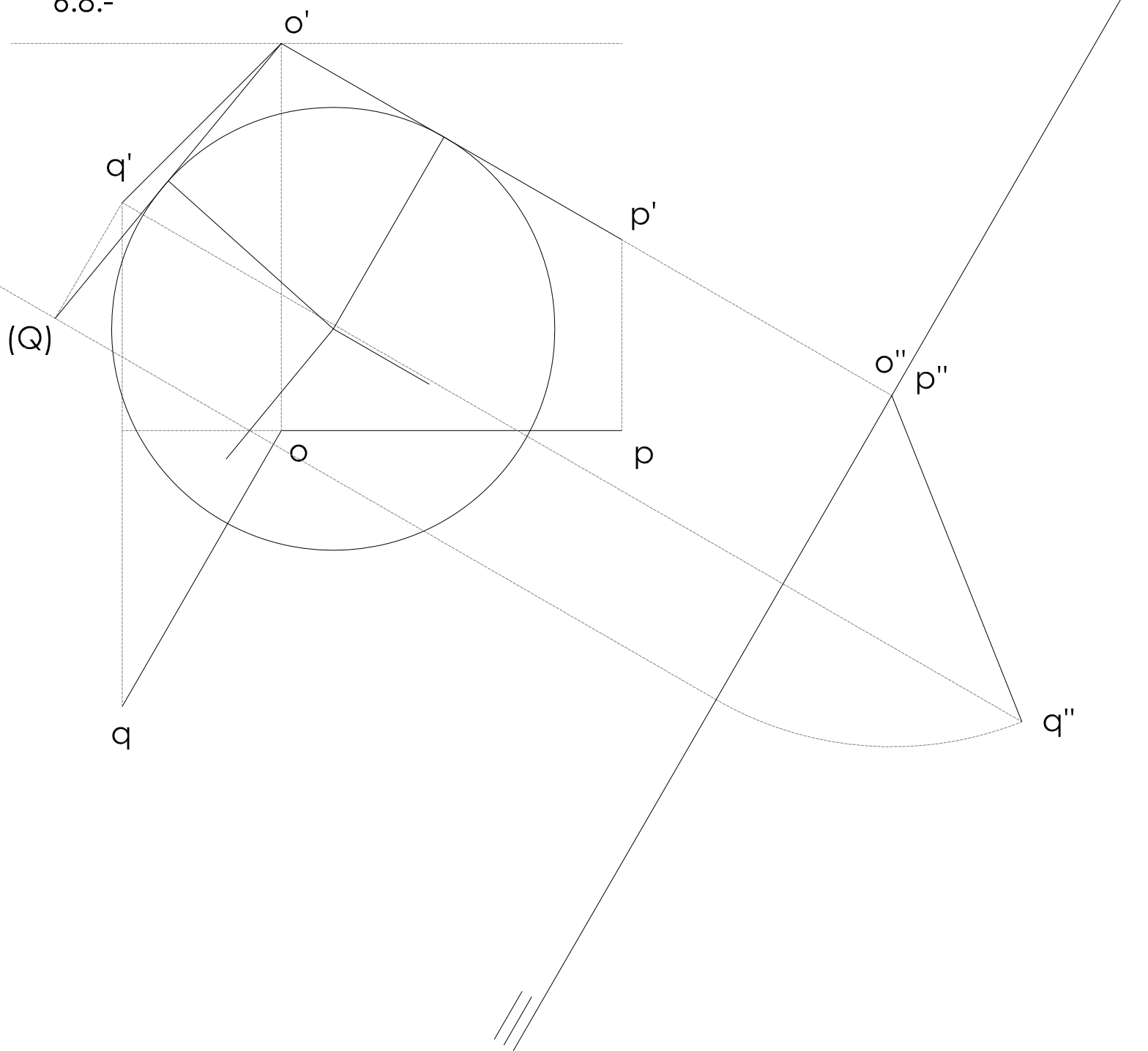

6.8.-

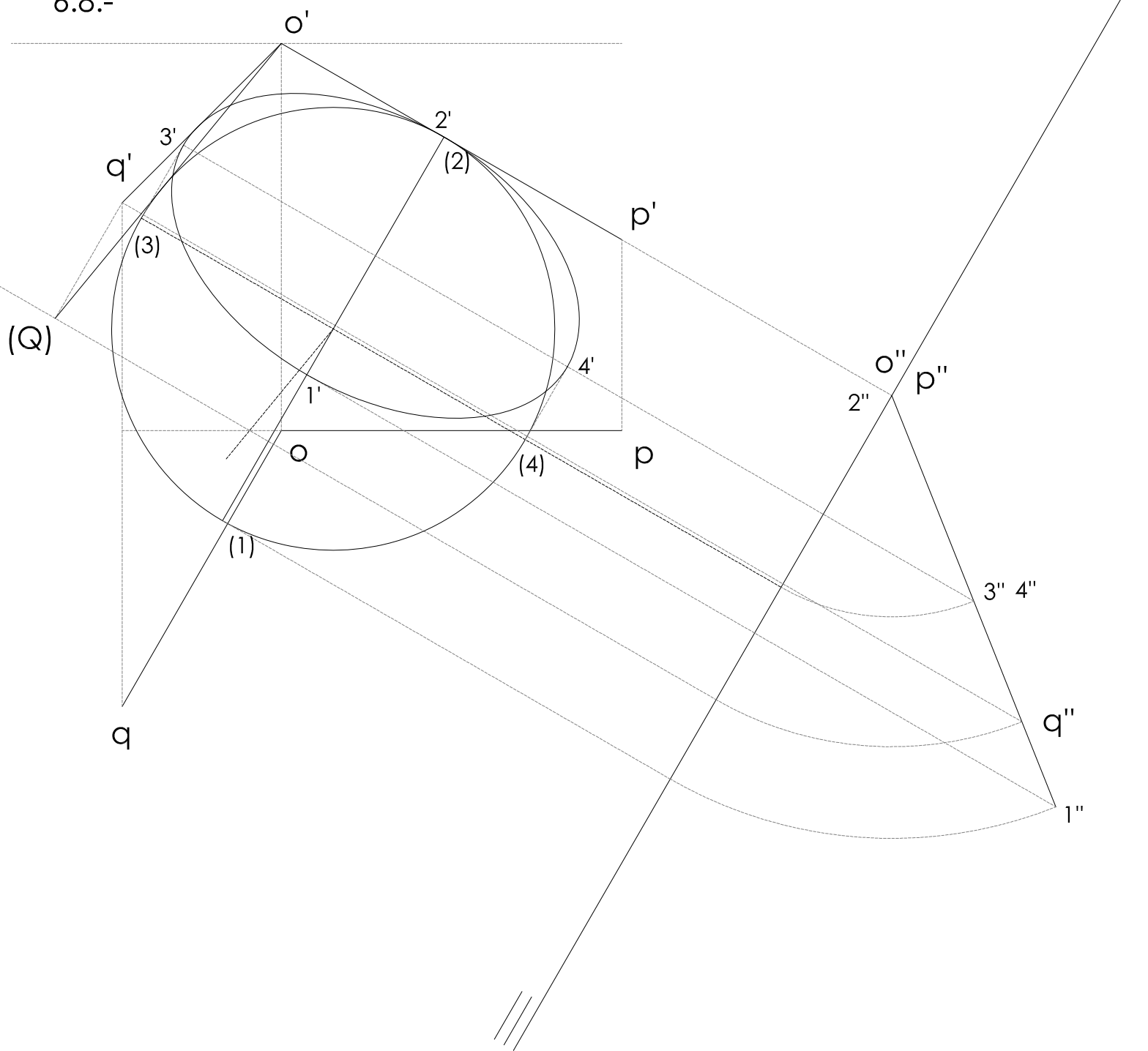



6.9.-

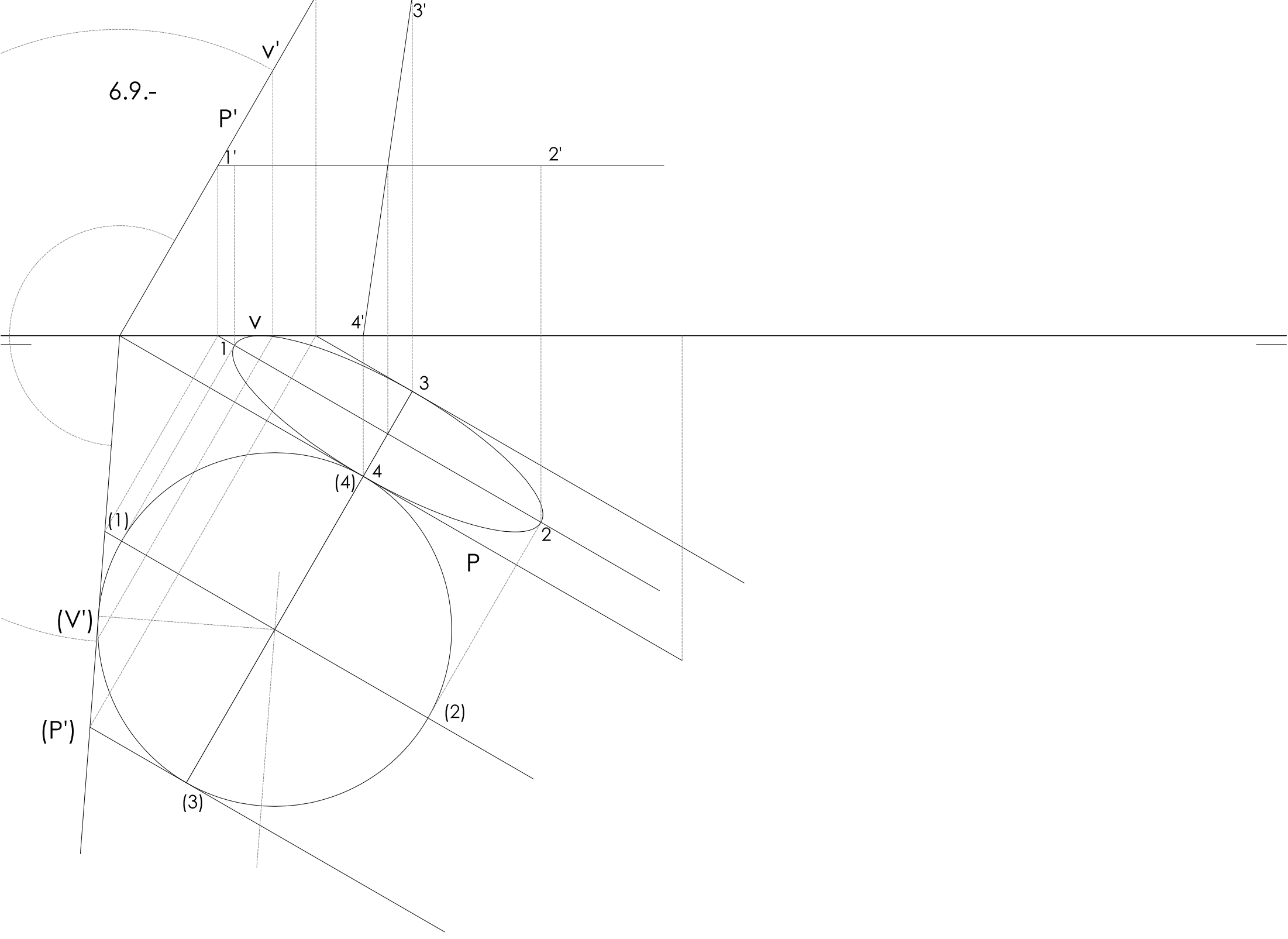

6.9.-

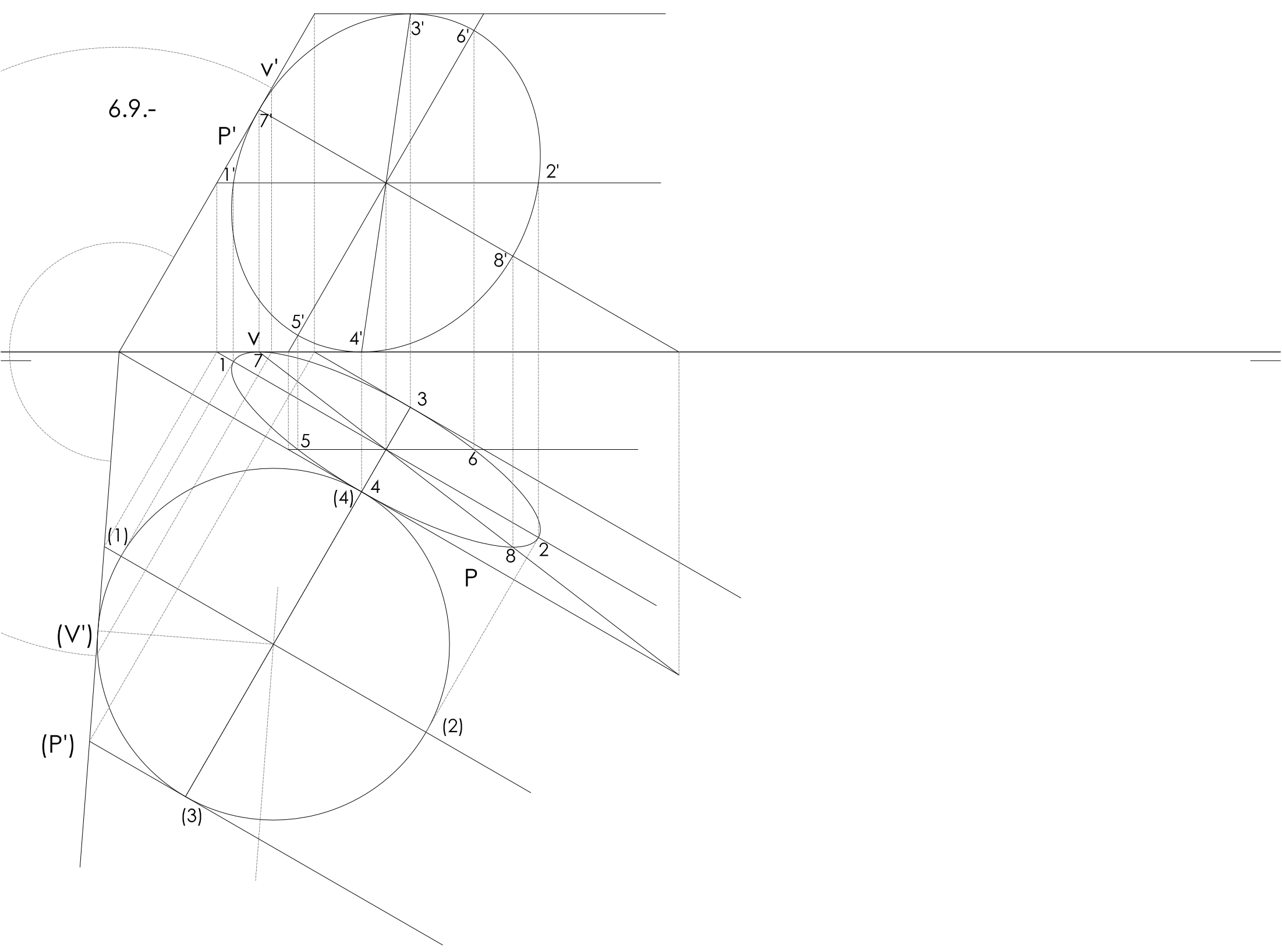

6.9.-

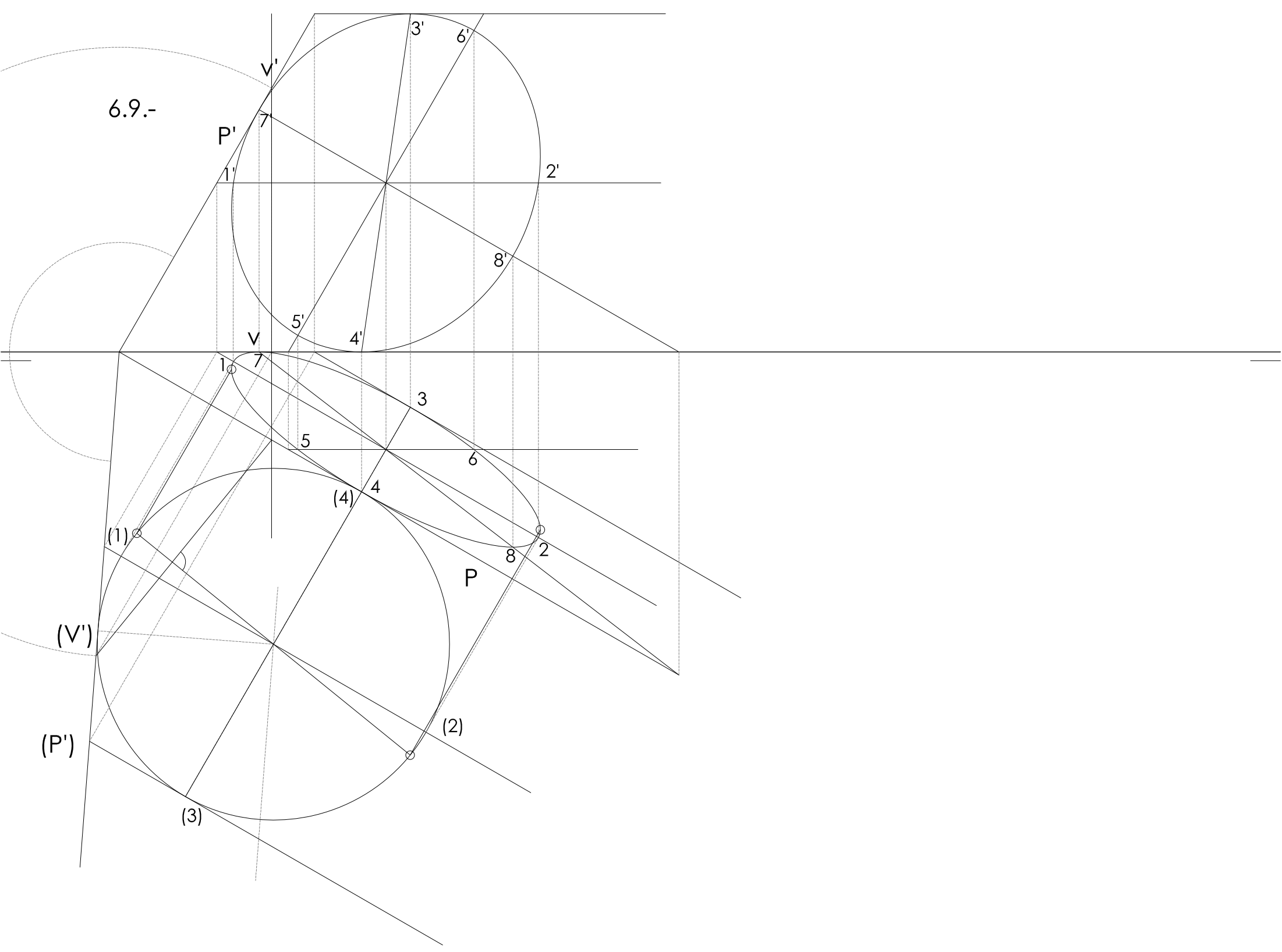



6.10.-

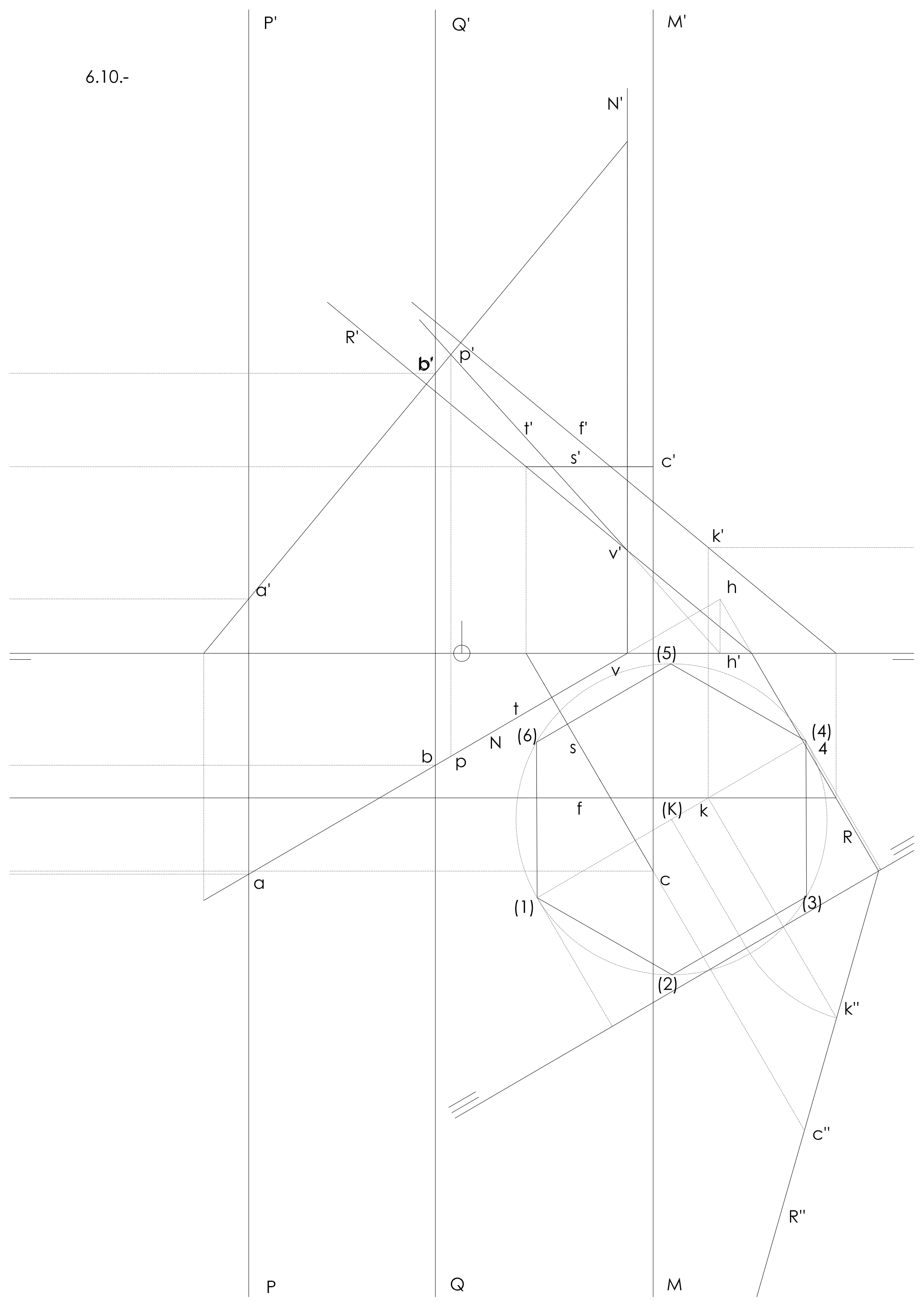



6.10.-

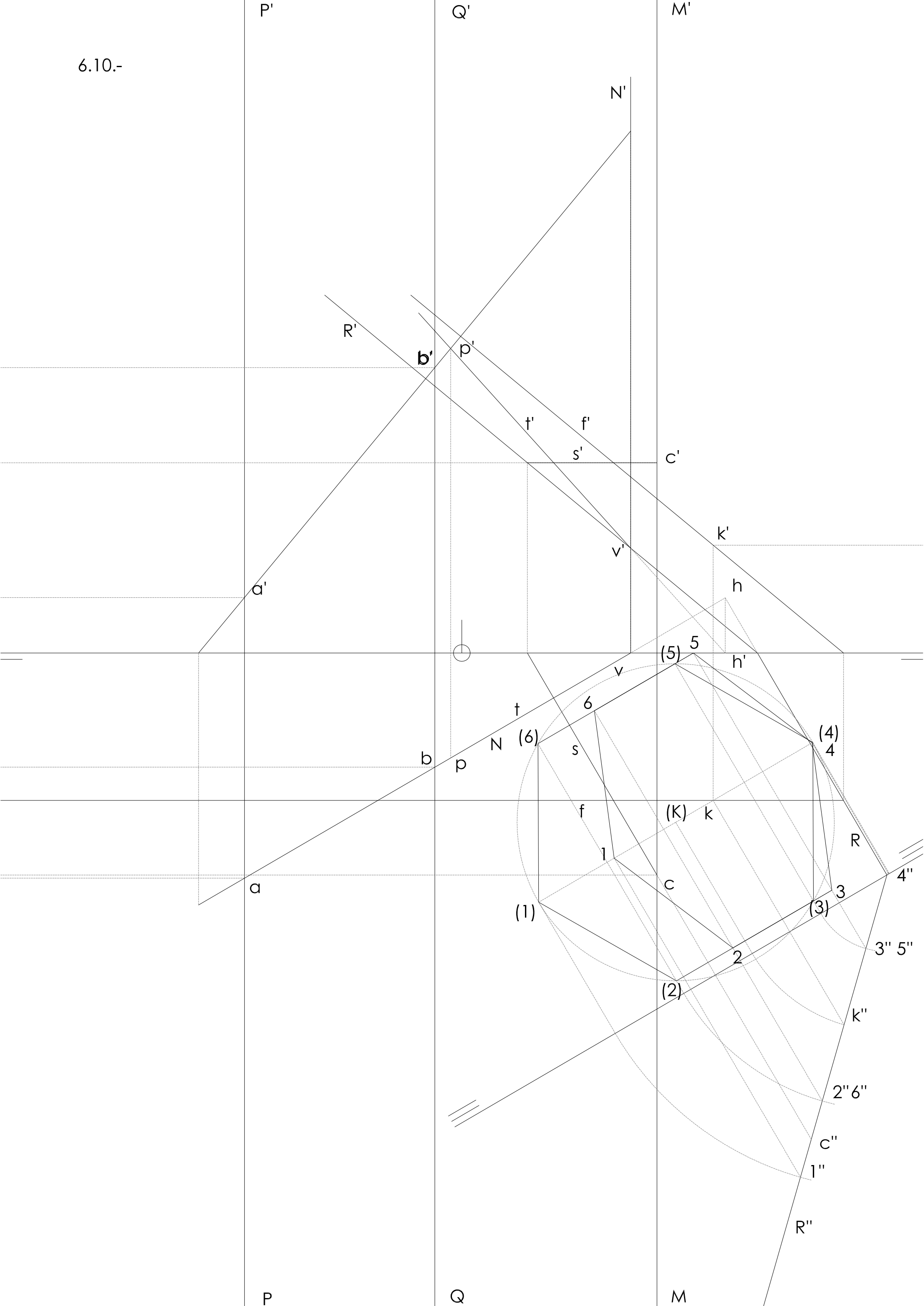

6.10.-

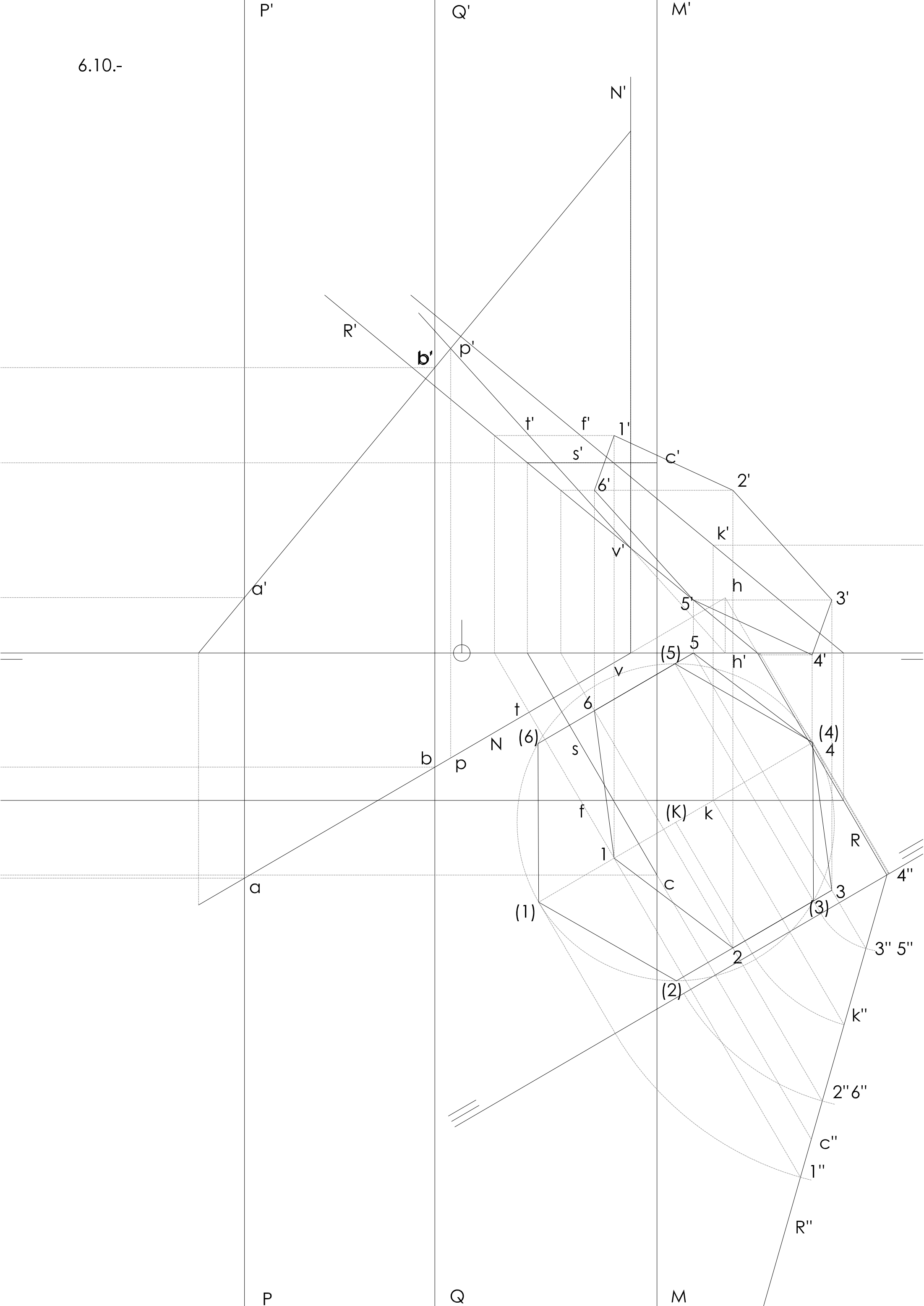

6.10.-

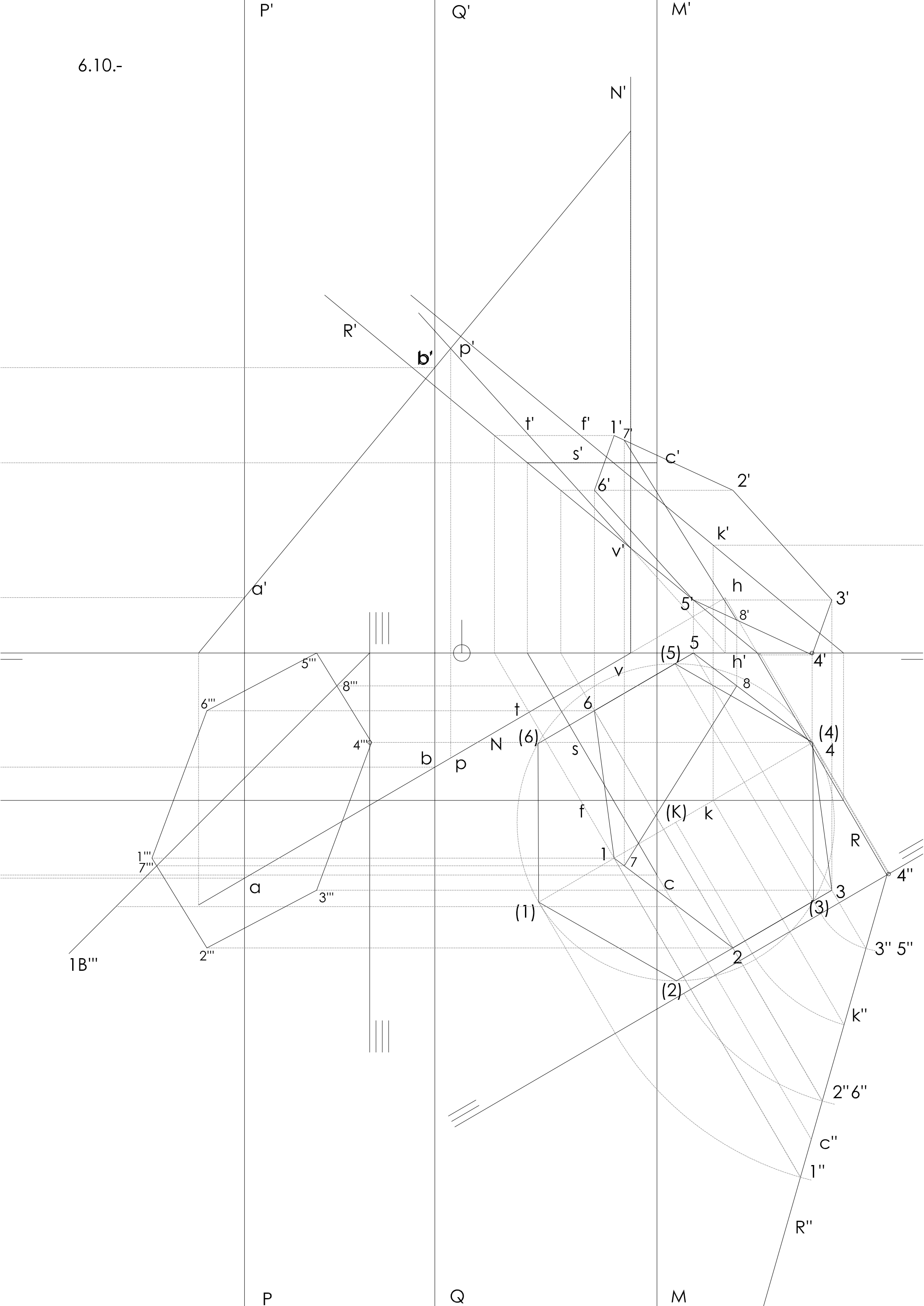

P'

Q'

M'

R'

b'

p'

N'

t'

f'

l'7'

s'

c'

2'

6'

k'

a'

h

8'

3'

5'

v'

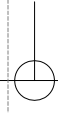

5'''

8'''

6'''

(5)

5

h'

8

4'

v

t

6

(6)

s

b

p

N

(K)

k

(4)

4

1'''

7'''

f

l

7

R

a

c

3'''

(1)

(3)

3

1B'''

2'''

2

(2)

3'' 5''



k''



2'' 6''

c''

1''

R''

P

Q

M

6.10.-

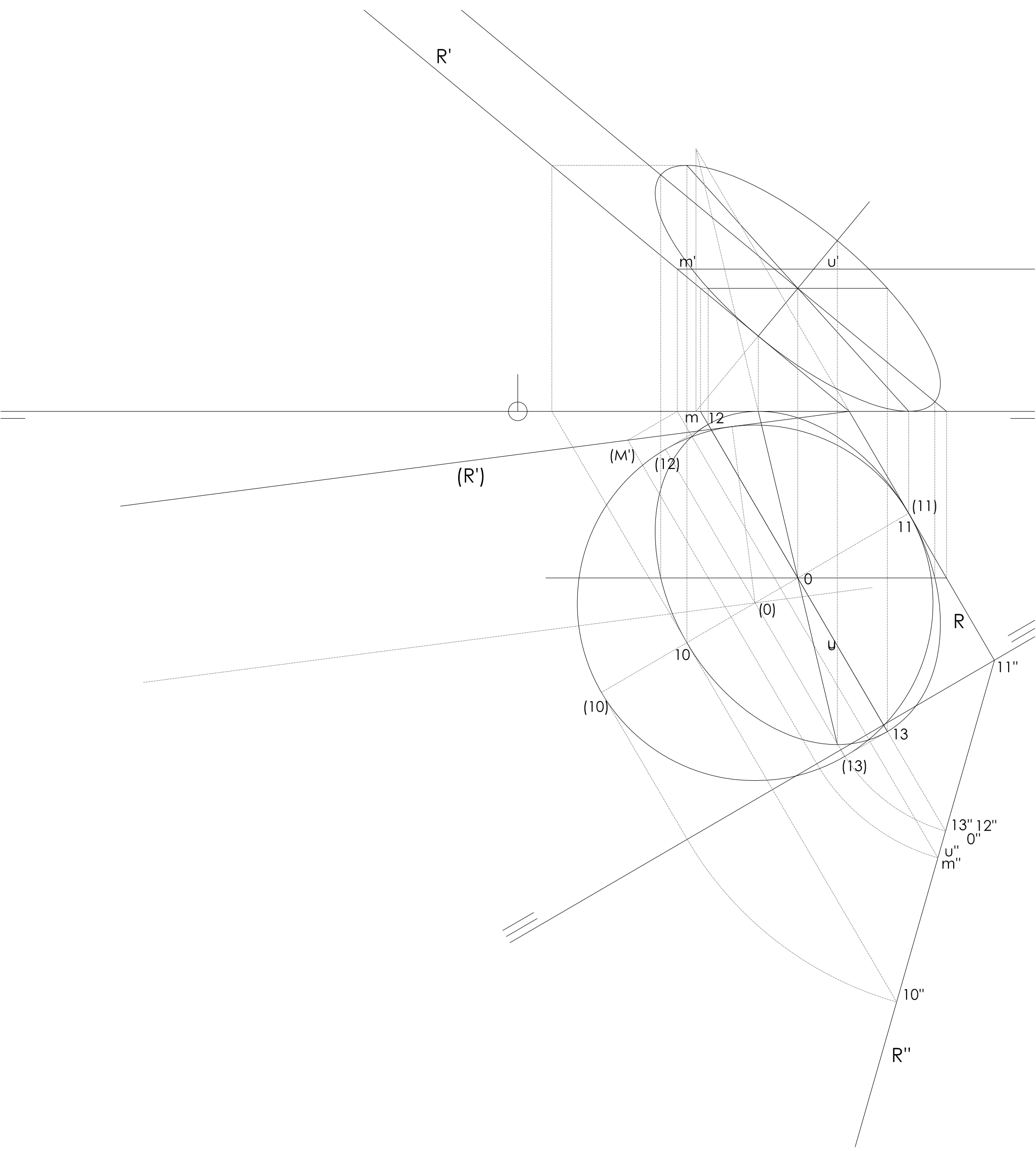

6.10.-

